

II. General Operating Instructions

A. Lighting Instructions

Gas and Electric - Read all safety information first. Turn gas cock clockwise to "OFF" position and temperature indicator to the lowest setting. Turn off all electric power to the appliance. Wait 5 minutes for gas to clear the area. Turn gas cock counterclockwise to "pilot" position, press reset button and light pilot, hold down until pilot remains lit. Turn gas cock counterclockwise to "ON" position. If pilot goes out, repeat above procedure. On initial start-up, this may take several times to purge the air from gas lines. Turn on all electrical power if combination electric/gas, and set temperature dial to desired setting. (CAUTION: Above 130°F will increase risk of scald.)

Gas and Electric With Reignitor - Place reignitor control in "OFF" position. Turn gas cock clockwise to "OFF" position, and temperature indicator to lowest setting. Turn off all electric power to appliance and wait 5 minutes for gas to clear. Turn gas supply and electrical power to appliance on. Turn gas cock counterclockwise to "pilot" position, press reset button and switch the electric reignitor module to "ON" position. Spark will start between electrode tip and pilot hood. When pilot lights, the spark will stop. Continue depressing reset button for approximately 1 minute or until light remains lit. On initial start-up, it may take several times to purge air from lines. Turn gas cock counterclockwise to "ON" position and set temperature dial to desired location.

When reignitor switch is in the "ON" position, it will operate automatically when the pilot flame is extinguished. When the vehicle is to be stored or the LP supply is to be turned off, be sure to turn the reignitor control switch to the "OFF" position. This will prevent the battery from being discharged (the reignitor will continue sparking). The reignitor has an alarm that will sound when the pilot is extinguished or the LP supply is turned off.

Direct Spark Ignition (3-Try Module Board) - Read all safety information provided. Turn off all electrical power to the appliance. Turn off gas supply and wait 5 minutes for gas to clear the area. Turn on gas and electrical supply to the appliance. Turn switch to "ON" position, there will be a 15-second purge before spark. If burner does not light on first try, it will automatically try two more times before going into lockout. Each ignition cycle will have a 15-second purge before spark. If lockout occurs before main burner lights, turn switch to "Off" position, wait 5 seconds and turn switch to "ON" position. This will restart the ignition cycle again. On the initial start-up, it may require several ignition cycles to purge all the air from the gas lines.

B. Voltage/Gas Pressure Requirements

The DSI water heater must have an acceptable DC-voltage range to function properly. An adequate voltage range would be between 10.5 volts DC and 13.5 volts. This voltage must be supplied directly from the battery or from the power converter wired in parallel with the battery.

The LP system working pressure should be 11" of water column (WC). When testing the pressure of the system, at least one other gas appliance needs to be in full operation to get accurate results. Check pressure with manometer at unit and pressure coming through orifice to get correct reading. Adjust accordingly. Do not overfill the propane tanks. The minimum working pressure is 11" WC, while the maximum is 14" WC.

C. Safety - Gas Leak Check

A leak in the LP gas system is a critical area that involves checking for and then repairing the leak. Most leaks occur when the system is open for service and improperly resealed when LP tanks are filled, or when appliances are installed. One way to check for leaks is to use a pressure gauge and simply pressurize the system and turn off the gas valve. If pressure drops, find the leak and correct it. A liquid leak solution can be applied to any fitting that was opened. Do not use a soap solution with ammonia, as it is corrosive to brass. Also the electronic gas sniffer is a must for finding leaks in hard-to-reach places.

III. Water Heater Overall Construction

A. Glass-lined Tank

The steel, glass-lined tanks provide long life under varying water conditions. This same construction is what is used for more than 7 million residential water heaters sold annually. The baked-on enamel process reaches temperatures in excess of 1600°F. Three (3)-year tank warranty, replaceable anode rod, high output, fast recovery, gas connection supplied, metal jacket on all gas/electric models, drain cock on tank.

B. Door Latch Assembly - See Figure 1, Page 6.

DOOR LATCH ASSEMBLY INSTRUCTIONS 150079

TO REPLACE DOOR LATCH ASSEMBLY REMOVE

HANDLE ONLY FROM DOOR LATCH ASSY. INSERT CLIP WITH SPRING FROM BACKSIDE OF DOOR LATCH BRACKET, THROUGH HOLE AND RESUME STEPS 2 & 3.

- (1) PUT SPRING OVER CLIP.
- (2) COMPRESS SPRING WITH HANDLE, AT SAME TIME MOVE HANDLE OVER INDENTATIONS ON CLIP.
- (3) SWING HANDLE INTO POSITION.

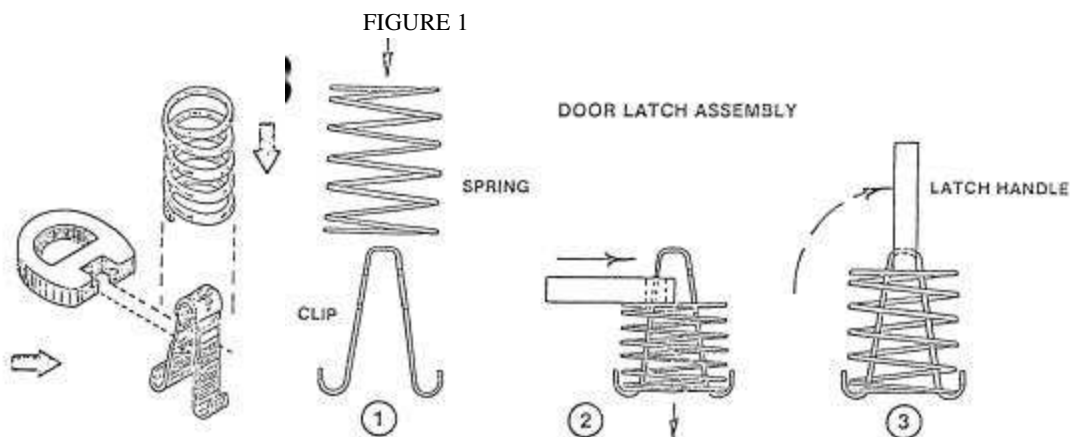

C. Anode Rod

A factor in the confidence we have in our tank life, this rod "absorbs" the corrosive effects that would otherwise tend to attack the tank itself. This rod is now made of magnesium instead of aluminum.

Inspections periodically depending on the corrosive condition of the water, the Suburban tank can last far longer than the 3-year warranty.

D. Temperature and Pressure Valve

Temperature and pressure relief valves will normally drip during heating cycles. In a closed system, a liquid will expand when heated and cause a rise in temperature and pressure. How much is excessive and why only sometimes? Here are six basic reasons:

1. The temperature and pressure of incoming water
2. The cleanliness of the thermostat or "probe" position of valve
3. The pressure setting of relief valve (150 PSI)
4. Age and condition of the spring assembly inside valve
5. The temperature setting of preset or manual thermostat
6. The elevation and atmospheric pressure at which the heater is used

E. Winterization/Flushing Instructions

If the RV is to be stored during winter months, the water heater must be drained to prevent damage from freezing. The following steps can be followed to do this:

1. Turn off power and gas.
2. Turn off pressure pump or your water hook-up source.
3. Open both hot and cold-water faucets.
4. Open drain on water heater.
5. Follow RV manufacturer's instructions for draining entire water system.

F. Odor from Hot Water System

Odor from the hot water system is not a service problem, and many water supplies contain sufficient amounts of sulfur to produce an odor. The odor is similar to rotten eggs and is often referred to as sulfur water. It is not harmful only unpleasant to smell. Sulfur water can be caused by a chemical action or by bacteria. The solution to eliminate is heavy chlorination of the water system. Add about six ounces of heavy chlorine (common household liquid bleach) to each ten gallons in the water tank. Then run the heavy chlorinated water throughout the system, opening each faucet one at a time until you smell the chloride. Let the RV sit for a few days and the chloride should take care of the problem. Then you'll need to take care of the chloride. You may consider adding a filtering system to chloride the water and prevent sulfur water.

IV. Gas and Electric Units

A. Gas Control System

1. Pilot Adjustment - Figures 2 and 3

a) Pilot will not come on:

- 1) Possible malfunction of the bottle gas regulator. Gas pressure should be 11" WC. Test and adjust at regulator.
- 2) Clogged pilot orifice - clean or replace.
- 3) Gas control defective; no gas flow - remove and replace.

b) Pilot will not stay on:

- 1) Improper pilot flames; should be a blue or orange-blue flame - adjust air shutter.
- 2) Obstructed pilot orifice clean or replace
- 3) Loose or weak thermocouple. Thermocouple can be checked with voltmeter, checking millivolts when flame is present. If loose, tighten; if defective, replace.
- 4) A defective E.C.O. switch or magnet in gas control -disconnect thermocouple from gas control. Check for continuity between control. housing and center of thermocouple fitting (do not touch the threaded portion with probe). If no continuity, replace the gas control.

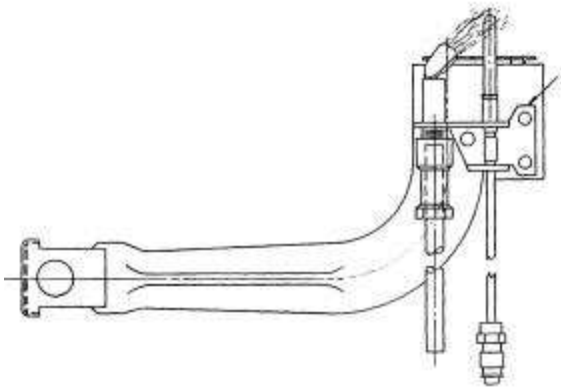

Figure 2

A. Gas Control System (continued)

2. Burner Adjustment

a) Erratic main burner flame sputtering yellow:

- 1) Incorrect gas pressure check for correct gas pressure coming through main burner orifice; should be 11" WC.
- 2) Check for blockage or obstruction in main burner orifice. Remove and clean with alcohol and compressed air. Do not enlarge orifice hole. Clean main burner if necessary.
- 3) Misalignment of main burner - check for correct alignment by adjusting tube and elbow in or out.
- 4) Misalignment of the flame spreader. Should be squared with the burner tube and not bend in or out.
- 5) Sooting - can be caused by thermostat not shutting off completely or other obstructions or blockage in flue box.

b) Main burner will not ignite:

- 1) Main burner orifice could be blocked - remove and clean with alcohol or compressed air. Do not enlarge orifice hole.
- 2) Improper air shutter adjustment - with the right fuel/air mixture, the main burner flame should be blue or orange blue. Adjust air shutter to this color; do not allow it to burn yellow as sooting can occur.
- 3) Lint or dirt in burner tube - clean burner tube.
- 4) Gas control valve defective - no gas flow through valve. Remove and replace.

AIR SHUTTER ADJUSTMENT
INSTRUCTIONS - Large Burner

1. Turn Air Shutter (B) to obtain proper blue flame

- A-BURNER TUBE
- B-AIR SHUTTER
- C-GAS COCK
- D-RESET BUTTON
- E-PILOT ADJUSTMENT
- F-TEMPERATURE INDICATOR
- G-SPRING

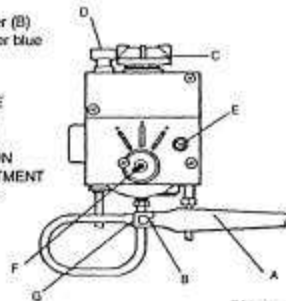
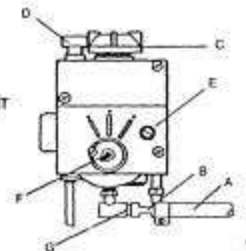

Figure 3

AIR SHUTTER ADJUSTMENT
INSTRUCTIONS - Small Burner

1. Loosen nut and bolt (G)
2. Slide air shutter (B) to the right or left to obtain the proper blue flame.
3. Secure nut and bolt.

- A-BURNER TUBE
- B-AIR SHUTTER
- C-GAS COCK
- D-RESET BUTTON
- E-PILOT ADJUSTMENT
- F-TEMPERATURE INDICATOR
- G-SPRING



A. Gas Control System (continued)

3. Temperature Adjustment - Figure 4

a) Water too hot:

- 1) Thermostat set too high. Adjust temperature to lower selection accordingly.
- 2) Pilot flame adjustment too high. Flame spreader misaligned - square with end of burner.

b) Not enough hot water:

- 1) Thermostat set too low. Adjust temperature to higher selection.
- 2) Misalignment of main burner - adjust and realign elbow on burner tube.
- 3) Obstruction in main burner or air intake - clean accordingly.
- 4) Main burner orifice too small or clogged - remove and clean or replace.
- 5) Improper air shutter adjustment - adjust to blue or orange-blue flame.
- 6) Thermostat gas control out of calibration - replace.

B. Gas Ignition System

1. Reignitor

A reignitor eliminates the need for matches to light the pilot. It will maintain a pilot flame under windy conditions, and has an alarm which will sound when the pilot flame is extinguished or if the LP gas supply is turned off. It is available on all pilot models. A reignitor can be field installed.

2. Installation and Operation

See Field Instructions for Reignitor Control.

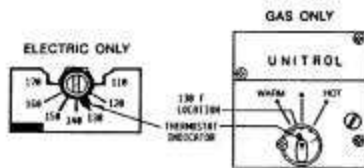

Figure 4

FIELD INSTALLATION INSTRUCTIONS for REIGNITOR CONTROL

NOTE: These instructions must be read and understood before attempting to install this reignitor control.

1. Turn gas cock (C) to "OFF" position (Fig. 11 or 11 a).
2. Turn thermostat temperature indicator (F) to its lowest position (Fig. 11 or 11 a).
3. Disconnect thermocouple nut (H) and remove from thermostat (Fig. 11 or 11 a).
4. Disconnect pilot tube nut (G) and remove pilot tube from thermostat (Fig. 11 or 11 a).
5. Loosen manifold nut (1) at thermostat (Fig. 11 or 11a).
6. Remove mounting screws (K) from burner support bracket (Fig. 12).
7. Remove burner assembly.
8. Cut out template and tape into place. See back of sheet for template. Drill hole per template. Be sure to read entire instruction before cutting out template.
9. Mount electronic reignitor module to control panel #6 screws *provided*. (**CAUTION: Oversized screws will break module housing**).
10. Run an 18GA wire from 12 volt source to water heater. Do not connect to 12V source at this time.

11. Refer to Figure 13. Connect red wire to 12 volt terminal DN ignition module.
12. Refer to Figure 14 for installation of the electrode assembly. Be certain that the ground wire is assembled per illustration and that the machine screw is tight.
13. Refer to Figure 15 for proper electrode tip position relative to the pilot hood. The distance between the electrode tip and pilot hood should be $125 (1/8)$ to $.187 (3/16)$ inch.
14. Replace burner assembly (Fig. 11).
 - a. Place burner onto burner manifold (J).
 - b. Replace mounting screws (K) (Fig, 12).
 - c. Align the manifold to the center line of the burner.
 - d. Tighten the manifold nut (I).
 - e. Reinstall pilot tube nut and tighten (Be careful not to cross thread the nut).
 - f. Reinstall thermocouple nut finger tight plus one quarter turn with a wrench (overtightening will damage electrical components).
15. Connect ground wire and electrode wire to electronic reignitor module per Figure 13.
16. Install strain relief bushing on 12 volt wire where it comes through the control housing.
17. Make sure the electronic reignitor module is in the "OFF" position (Fig. 13).
18. Connect supply wire to 12 volt power source.
19. Turn gas cock to pilot position (C) (Fig. 11).
20. Depress reset button (D) (Fig. 11) on thermostat.
21. While depressing reset button, switch the electronic reignitor module to "ON" position. Spark will start between electrode tip and pilot hood.
22. When pilot lights, spark will stop, Continue depressing reset button for approximately one minute or until pilot remains lit.
23. Turn gas cock to "ON" position (C).
24. Set temperature indicator (F) (Fig. 11) to desired temperature. **(CAUTION: Setting the temperature Indicator past the middle Indicator mark will Increase the risk of scald Injury. Small children or Invalids may require a lower temperature setting).**
25. With burner on, check for gas leak at pilot tube nut and manifold nut using a soap solution or leak detecting solution **WARNING: Never use aflame to check for gas leak.**

NOTES:

1. When the reignitor switch is in the "ON" position, the reignitor will operate automatically when the pilot flame is extinguished.
2. When the vehicle is to be stored or the LP gas supply is to be turned off, be sure to turn the reignitor control switch to the "OFF" position. This will prevent the battery from being discharged (the reignitor will continue sparking).
3. The reignitor has an alarm which will sound when the pilot is extinguished or if the LP supply is turned off. The alarm will serve as a reminder to turn off the reignitor.

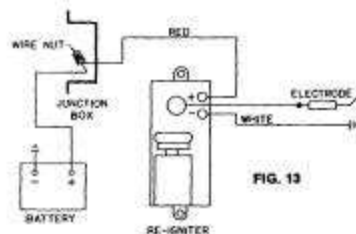
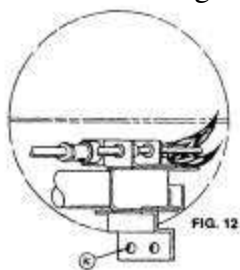
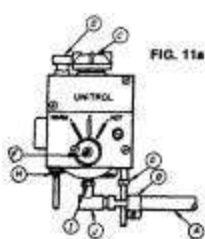
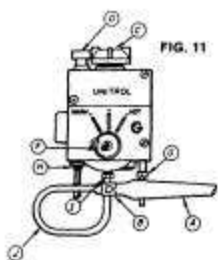

LIMITED WARRANTY:

This product is warranted to the original purchaser against defects in workmanship and material defects for a period of 1 year from the J'te of purchase, provided the product has not M.en damaged by misuse or negligence. dModucts returned for warranty must be sent prepaid for examination and verification of warranty and Suburban reserves the right to be the sole judge thereof. Suburban's liability is specifically limited to replacing or repairing the product, at Suburban's option. This warranty does not cover damage by accident, misuse, or failure to follow operating instructions.

NOTE:

Some states do not allow limitations on how long an implied warranty lasts and the exclusion or limitation of incidental, consequential, special or contingent damages or expenses, so the above limitations and exclusions may not apply to you. Further, this warranty gives you specific legal rights, and you may also have other rights which may vary from state to state.

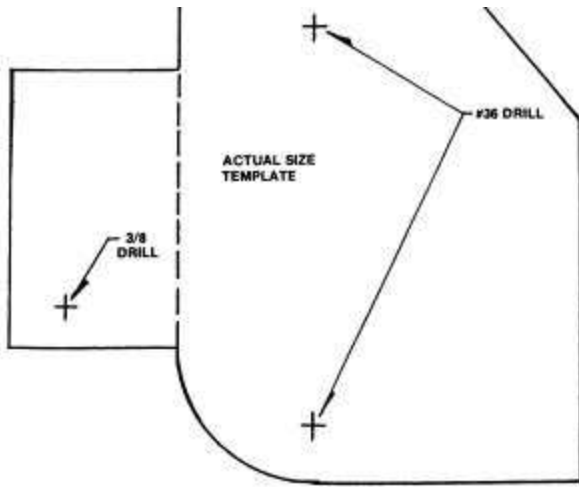
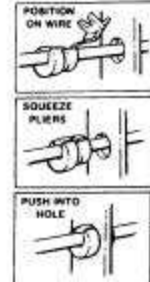
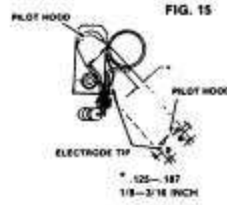
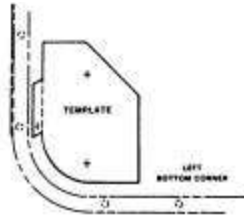
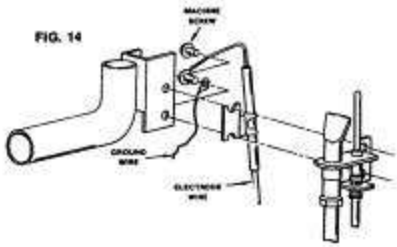

C. Electric System - Figure 5

1. Electric Thermostat and Element

Electric water heaters are designed to operate with a minimum amount of service problems. The most common trouble with electric water heaters results from energizing the heater before it is filled with water.

Check the following items:

- a) Check for 120-volt AC to the ON/OFF switch on back of the gas/electric water heater. If voltage is present on both sides of the switch and the heater still doesn't work, replace switch.
- b) Check the circuit breaker in the coach to make sure it has not tripped.
- c) Remove the water heater electrical access cover and press the red reset button on the heater. (Power should be turned off when removing the door cover).
- d) If, after pressing the reset button and turning the power back on, the heater still fails to operate, turn off the power and check all wire connections.
- e) After the first four steps have been followed, the heating element should be checked for continuity with a voltmeter or other testing device. If defective, replace with any 120V AC element of the same or lower voltage.

Secondary problems with electric water heaters are rare; however, they can be corrected by minor thermostat adjustments. If the water heater becomes too hot and activates the reset control, reset the red reset button.

In cases where the water is too hot and the high limit control is not shutting off the heater, it is possible that the thermostat is loose from its bracket and is not being held tightly against the tank.

WIRING DIAGRAM (120 VAC)

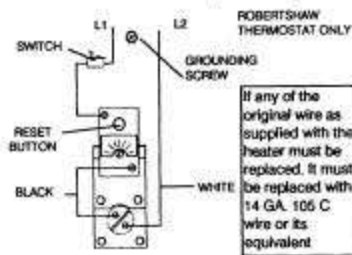

Figure 5

V. Direct Spark Ignition

A. Understanding the Operating System - Figures 6 and 7

The direct spark ignition water heater must have not only the correct gas pressure but a DC voltage range between 10.5 volts DC and 13.5 volts. This voltage should be supplied directly from the battery or from the "filtered" circuit of a converter. On a call for heat, voltage is applied to the igniter across terminals 1 (power) and 6 (ground) of the input connector. A high voltage spark is then generated from the spark electrode to ground. Simultaneously, the gas valve is energized. At the start of each heating cycle, there is a 15-second purge followed by a 6.8-second trial for ignition. Sparking ceases as soon as a constant flame is present. If no flame is detected within 6.8 seconds on the first try for ignition, the system will automatically try two more times before going into lockout. Once the flame is established, sparking will cease and the "flame rod" will provide flame monitoring for the remainder of the heat cycle. If the flame is extinguished during this cycle, it will spark automatically in an attempt to re-establish the flame. If lockout occurs, the valve closes, turning on the red light in the ON/OFF switch.

Direct Spark 3-Try Ignition

Model Series 05-30

Part #231463

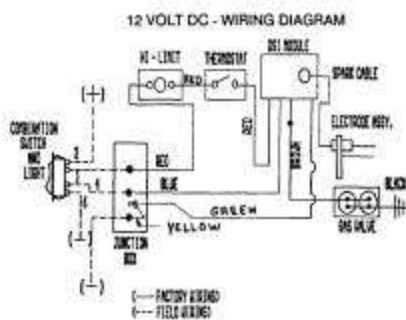

Figure 6

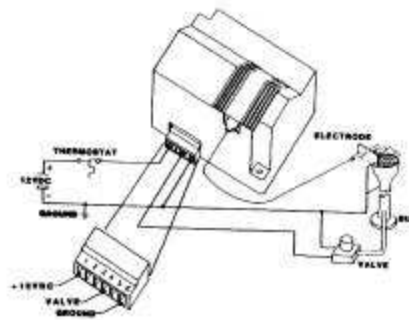

Figure 7

APPLICATION NOTE

FLAME CURRENT MEASUREMENT - SERIES 05-30

Local Flame Sensing (Single Spark and Sense)

With power off, connect a DC microammeter (D'Arsonval movement type) as shown in Figure 1. (The meter should be protected from high voltage surges which could damage the meter movement. A 1.5. LIF 200 volt film capacitor across the meter terminals or lead wires will provide adequate protection.) The lead wires and terminals must be isolated from other surfaces to prevent the H.V. signal from arcing to ground during the trial-for-ignition period.

Apply power. Once the flame is established and the sparks shut off, a flame sense current of 1.5 PA DC minimum is required for proper operation.

Figure 1: Local Flame Sensing (Single Spark and Sense) 05-30 Direct Spark Ignition System

CAUTION: Due to possible shock conditions, do not touch the microammeter or lead wires during the flame sense test. Always remove power before making any adjustments.

(continued)

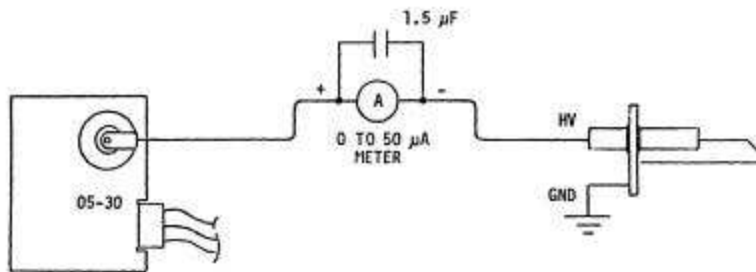

Remote Flame Sensing

With power off, remove the sense wire from the electrode terminal and install a DC microammeter in series with the electrode terminal and sense wire, as shown in Figure 2. apply power. Once flame is established, a flame sense current of 1.5 uA DC minimum is required for proper operation.

Figure 2: Remote Flame Sensing
05-30 Direct Spark Ignition System

When Remote Flame Sensing is used, it is not necessary to employ the 1.5.UF protection capacitor across the meter. However, since it does not affect the performance of the microammeter, it may remain in place at all times.

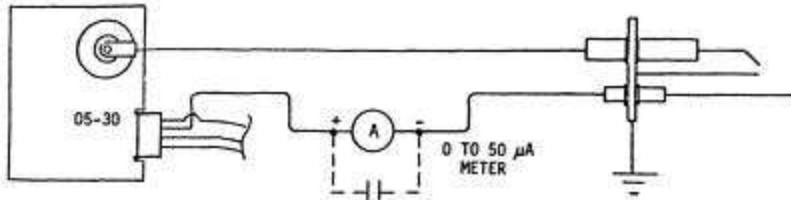

B. Diagnosis and Repair

1. Flashback in Burner Tube

- a) Incorrect gas pressure. Gas pressure should be 11" WC.
- b) Misalignment of burner tube. Burner orifice should be positioned down the center of the burner tube. Burner should be aligned with gas valve.
- c) Improper air shutter adjustment. Flame should be blue to blue-orange; adjust accordingly.

ALL SUBURBAN WATER HEATERS
WITH SINGLE SPARK AND SENSE IGNITION

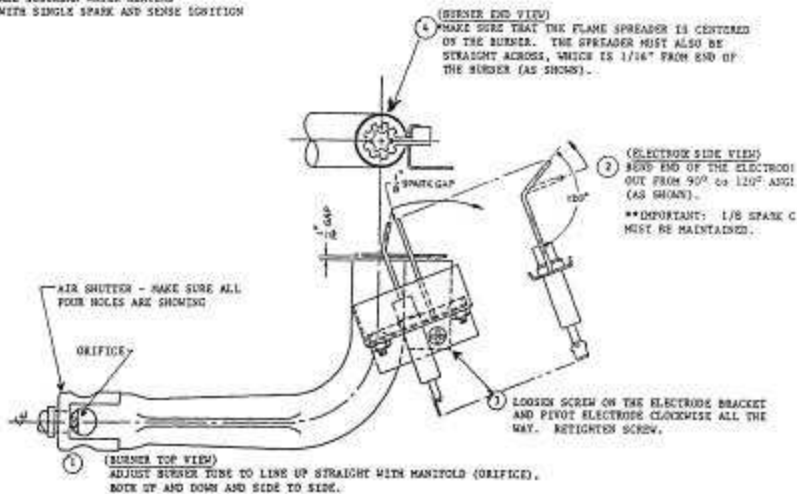

Figure 8

B. Diagnosis and Repair (continued)

2. Thermostat Failure and ECO Switches

Suburban's direct spark ignition water heaters have a preset thermostat of 130 degrees Fahrenheit that is non-adjustable. It is also equipped with a high temperature limit (E.C.O.) as a cut-off device. Temperatures above 180°F will cause manual reset button to trip, shutting down the main burner. To activate the burner, the water temperature must be below 100°F, push the reset button to reactivate the burner. Make sure the thermostat bracket is holding both switches tight against the water heater to ensure that both of them sense correctly. Check all wire terminals and voltage through the E.C.O. and thermostat.

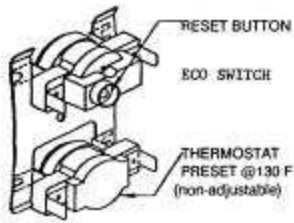

Figure 9

B. Diagnosis and Repair (continued)

3. The Electrode Assembly

Positioning of the electrode assembly is very important. The gap **between spark and ground should be 1/8"** (Fig. 10). The spark and **ground probe should not be** grounded to the flame spreader or any other metal object in the combustion chamber. The sensing probe relays to the circuit board a signal that a flame is present. This signal is a small DC current which can be measured directly with a 0 to 50 microamp meter. Although the minimum flame current necessary to keep the ignitor from going into lockout is 1.5 microamps, the meter readings should be 3.0 microamps or higher.

To measure flame current, first shut off the power to the system and then remove the flame sensing lead wire from the electrode terminal and insert the microamp meter in series with the sensor electrode and ground. "Plus" terminal of meter to component board and "negative" terminal to sensing electrode. Energize the ignitor. If microamps too small, check the following:

- a) Check for correct input polarity. Terminal 1 should be "hot" (12 volts DO with respect to ground. Terminal 6 is neutral, or zero voltage, with respect to ground.
- b) Improper grounding - if a flame is present during the trial for ignition period but the system shuts down, make sure the burner is properly grounded. If not, the system will go into lockout.
- c) Check the electrode ceramic for cracks or carbon. Make sure the electrode is free from carbon deposits and is not corroded or pitted.
- d) Check electrode leads for corrosion at the terminals. If there is corrosion, clean it off.
- e) Check the sensor wire for continuity. If defective, replace it.
- f) Re-position the electrode assembly and check the spark gap. If the gap is too wide, damage to the ignitor can result.

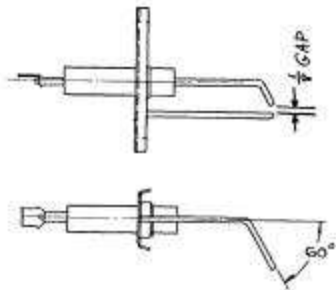

Figure 10

3. The Electrode Assembly (continued)

If no spark is present, check the following:

- a) Check for voltage to the circuit board. Terminal I should have voltage. If no voltage, clean wire connections at circuit board with pencil eraser.
- b) If still no voltage, check voltage through *E.C.O.* and thermostat. Make sure there are good connections and voltage present. If voltage is present on one side but not the others, replace thermostat or *E.C.O.*
- c) If voltage is present through *E.C.O.* and thermostat to the module board, and no sparking occurs, replace the circuit board.
- d) After replacing the circuit board, if there still is no spark, check the high voltage wire for cracks or breaks, and replace if necessary.
- e) Make sure the high voltage wire is not too close to a metal surface to ensure that arcing will not occur other than across the electrode. Also ensure that the high voltage wire is not taped or connected to a metal frame along its length. Make sure the length is not more than 42" and it is clear from dust and moisture.

4. Gas Valve Malfunction

With power supplied to ignitor, sparking should occur and the gas valve should open simultaneously. If sparking occurs but the valve does not open, check the following:

- a) Place a voltmeter between terminal 4 on the input connector and ground (or across the valve). Recycle the ignitor by turning the ON/OFF switch to "off" for 5 seconds and then back on to determine if voltage is present at the valve.
- b) If voltage is present and the valve still does not open, remove wires from valve terminals and retest the valve on a known voltage source. If valve does not function still, it should be replaced.
- c) Check the circuit board connector for good connections.
- d) If voltage is not present at terminals 4 and 6 or at the valve, replace the circuit board.

5. Circuit Board Failure

- a) Check for the correct voltage (between 10.5 volts and 13.5 volts DC). Excessive voltage will damage the circuit board.
- b) Check spark gap. If the gap is too wide and arcing to ground, damage can occur to the circuit board.